

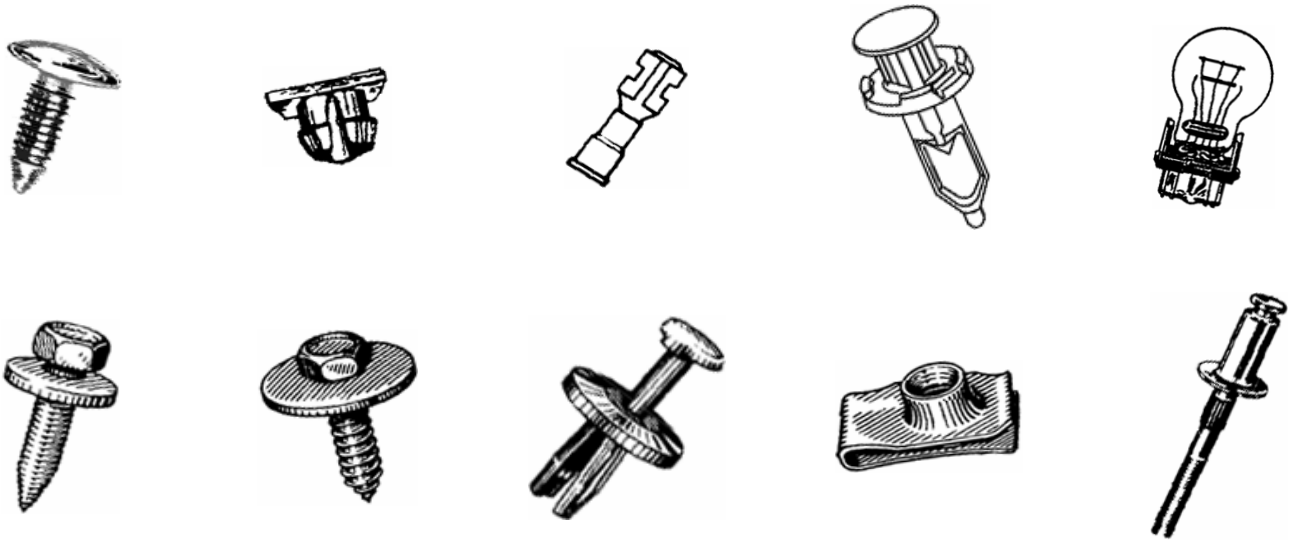

BODY SHOP FASTENERS



Distributed by:

***"THE SOURCE
FOR PROFESSIONALS
IN THE
AUTO BODY INDUSTRY"***

Body Shop Fasteners



... The Professionals' Choice

PLASTIC FASTENERS

1002

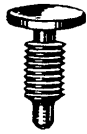

(OE 411700)
TRIM PANEL RETAINER
GM & UNIVERSAL

PKG: 50...250...500

1003

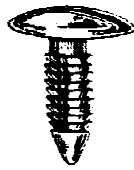

(OE 1605396, 6030441)
BLACK PLASTIC SHIELD
RETAINER - UNIVERSAL

PKG: 50...250...500

1919



(OE W708035-S300)
7mm HOLE - BUMPER
COVER RETAINER
FORD & UNIVERSAL

PKG: 40...200...400

1978



(OE W707889-S300)
1/4" (6.4mm) HOLE
MUD FLAP RETAINER

PKG: 20...100...200

1662

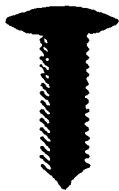

(OE 10185925)
BLACK INTERIOR TRIM
7mm HOLE - 20mm HEAD
GM, FORD & UNIVERSAL

PKG: 20...100...200

1645

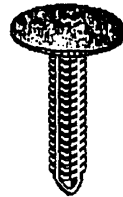

(OE 22575287, N804349S)
9/32" (7.1mm) HOLE
BLACK TEXTURED HEAD
PANEL RETAINER

PKG: 20...100...200

1007

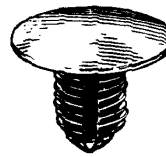

(OE 1619321)
PANEL FASTENER
CADILLAC & GM

PKG: 25...125...250

1656



(OE 1631564, N804379S)
BUMPER FASCIA RETAINER
10mm HOLE - 21mm HEAD
GM, FORD & UNIVERSAL

PKG: 20...100...200

2009



(OE 6502842, 21039129)
HOOD INSULATION
RETAINER
CHRYSLER & GM

PKG: 25...125...250

1923



(OE 2998430)
HOOD INSULATION &
TRIM PANEL CLIP
CHRYSLER & UNIVERSAL

PKG: 20

1976



(OE 20064875)
HOOD INSULATION
RETAINER
GM & UNIVERSAL

PKG: 25

1008



(OE 3078511)
(OE 3977775)
HOOD INSULATION CLIP

PKG: 25...100...200

1706



(OE N807438S)
WEATHERSTRIP RETAINER
FORD & HONDA - 5mm HOLE

PKG: 50...250...500

1741



(OE 10405030, 10283414)
WEATHERSTRIP RETAINER
GM - 5.5mm HOLE

PKG: 50

1703

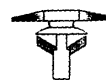

(OE 21077575, 21097292)
WEATHERSTRIP RETAINER
GM (SATURN) & CHRYSLER

PKG: 50

1653



















(OE N806289-S)
BLACK NYLON
WEATHERSTRIP RETAINER
FORD 1989-on

PKG: 50

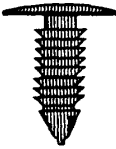

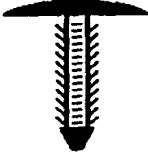
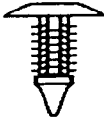
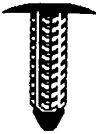
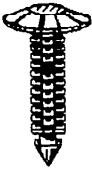
UNIVERSAL PUSH-IN FASTENERS

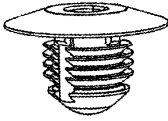
<p>1688</p>  <p>(OE 20729523) 7/64" (2.5mm) HOLE BLACK PLASTIC SHIELD RETAINER</p> <p>PKG: 50</p>	<p>1631</p>  <p>(OE 90687-671-0030) 5/32" (4mm) HOLE BLACK PLASTIC SHIELD RETAINER</p> <p>PKG: 50</p>	<p>1632</p>  <p>(OE 10169777) 3/16" (4.5mm) HOLE BLACK PLASTIC SHIELD RETAINER</p> <p>PKG: 25...125...250</p>	<p>1001</p>  <p>(OE 1616923) 3/16" (4.5mm) HOLE WEATHERSTRIP RETAINER</p> <p>PKG: 25...125...250</p>	<p>1633</p>  <p>(OE 2964547) 3/16" (4.5mm) HOLE WEATHERSTRIP RETAINER</p> <p>PKG: 25</p>
<p>1634</p>  <p>(OE 25016383) 3/16" (4.5mm) HOLE BLACK DASH PANEL RETAINER</p> <p>PKG: 50</p>	<p>1636</p>  <p>(OE 20699808) 13/64" (5.3mm) HOLE WEATHERSTRIP RETAINER</p> <p>PKG: 50...250...500</p>	<p>1637</p>  <p>(OE 4658673) 13/64" (5.3mm) HOLE WEATHERSTRIP RETAINER</p> <p>PKG: 50</p>	<p>1638</p>  <p>(OE N80101994S) 13/64" (5.3mm) HOLE BLUE PLASTIC SHIELD RETAINER</p> <p>PKG: 50</p>	<p>1639</p>  <p>7/32" (5.5mm) HOLE BLACK PLASTIC SHIELD RETAINER</p> <p>PKG: 50</p>
<p>1640</p>  <p>(OE N808370-S) 7/32" (5.5mm) HOLE BLACK PLASTIC SHIELD RETAINER</p> <p>PKG: 20</p>	<p>1643</p>  <p>(OE 332364) 1/4" (6.4mm) HOLE BLACK PLASTIC SHIELD RETAINER</p> <p>PKG: 50</p>	<p>1006</p>  <p>(OE 6270163) GREY PLASTIC SHIELD RETAINER UNIVERSAL</p> <p>PKG: 50</p>	<p>1644</p>  <p>(OE 6501067) 1/4" (6.4mm) HOLE BLACK FASCIA PANEL RETAINER</p> <p>PKG: 25</p>	<p>1635</p>  <p>(OE 65021040) 1/4" (6.4mm) HOLE BLACK PLASTIC SHIELD RETAINER</p> <p>PKG: 25...125...250</p>
<p>1648</p>  <p>(OE 21094146) 5/16" (7.8mm) HOLE BLACK TRIM PANEL RETAINER</p> <p>PKG: 25...125...250</p>	<p>1646</p>  <p>(OE 15975244) 5/16" (7.8mm) HOLE BLACK PLASTIC SHIELD RETAINER</p> <p>PKG: 20</p>	<p>1641</p>  <p>(OE 140714081) 5/16" (7.8mm) HOLE BLACK REAR HOOD SEAL RETAINER</p> <p>PKG: 25</p>	<p>1649</p>  <p>(OE N807721-S) 23/64" (9mm) HOLE BLACK TRIM PANEL RETAINER</p> <p>PKG: 50...250...500</p>	<p>1894</p>  <p>(OE 15056810) (OE 6505686AA) BUMPER RETAINER 12.5mm HOLE GM & CHRYSLER</p> <p>PKG: 15</p>



PUSH-IN FASTENERS

1011

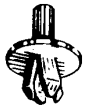

(OE 14005089)
**BLACK PLASTIC
 DRIVE RIVET
 UNIVERSAL**

PKG: 20

1012



(OE 14019205-6)
**FRONT FENDER MUD SKIRT
 DRIVE RIVET
 6mm HOLE
 GM & UNIVERSAL**

PKG: 50...250...500

1692



(OE 14071289)
**DRIVE RIVET
 8mm HOLE
 GM, FORD & CHRYSLER**

PKG: 25

1013



(OE 383142-S)
**PLASTIC RIVET
 1/4" HOLE
 FORD & UNIVERSAL**

PKG: 25

1651

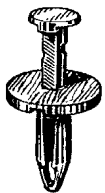

(OE N803362, 20510029)
**DRIVE RIVET
 6.3mm HOLE
 GM & FORD**

PKG: 25...125...250

1974

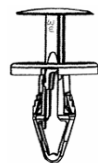

(OE 11589290)
**DRIVE RIVET
 6.5mm HOLE
 GM & UNIVERSAL**

PKG: 20...100...200

1652



(OE N803421S)
**PUSH RIVET - NYLON
 7mm HOLE
 FORD & CHRYSLER**

PKG: 20...100...200

1650



(OE 21030249, 807389S)
**PUSH RIVET - NYLON
 8mm HOLE
 GM (SATURN) & FORD**

PKG: 25...125...250

2064



(OE 11518017, 708530-S300)
**PUSH RIVET - 8mm HOLE
 GM, FORD & UNIVERSAL
 (LONGER THAN #1650)**

PKG: 15

1661



(OE 21075686)
**DRIVE RIVET - FASCIA
 8mm HOLE
 FORD**

PKG: 20...100...200

1689

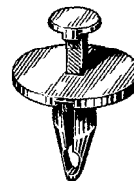

(OE N804614-S, 20570245)
**PUSH-TYPE RIVET
 8mm HOLE
 GM & FORD**

PKG: 20...100...200

1977



(OE 10157900, 15993201)
**PUSH RIVET
 9.5mm HOLE
 GM & UNIVERSAL**

PKG: 20

1972



(OE 11561368)
**PUSH RIVET
 9.5mm HOLE
 GM & UNIVERSAL**

PKG: 20...100...200

1690

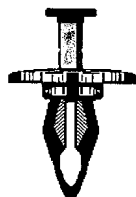

(OE 22535007)
**PUSH-TYPE RIVET
 9.5mm HOLE
 GM & UNIVERSAL**

PKG: 15

1010



(OE 5973400)
**PLASTIC RIVET
 BUMPER STRIP - GM**

PKG: 15



PLASTIC FASTENERS

1691



(OE 20664092)
(OE N804570S)

TRIM RETAINER
6.3mm HOLE
GM, FORD & CHRYS

PKG: 20...100...200

1659



(OE N803946S)
(OE 6502871)

PUSH TYPE RETAINER
6.3mm HOLE
FORD & CHRYSLER

PKG: 20

1657

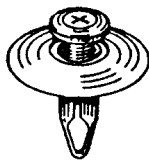

(OE N804837S)

PUSH TYPE RETAINER
1/4" HOLE
FORD & UNIVERSAL

PKG: 20...100...200

1654

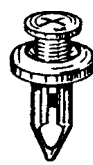

(OE 10053182)

PUSH TYPE RETAINER
8mm HOLE
GM & UNIVERSAL

PKG: 25

1655



(OE 10140480)
(OE 309414)

PUSH TYPE RETAINER
12mm HOLE
GM & FORD

PKG: 15...75...150

1015



(OE 140177689)

PLASTIC SCREW RIVET
1/4" HOLE
GM "X" BODY

PKG: 25

1016



(OE 14015161)
(OE 175-853-695A)

GRILLE FASTENER
GM & V.W.

PKG: 25

1017



(OE 14039420)

BLACK PLASTIC RIVET
GM & UNIVERSAL

PKG: 25

1018



(OE 14032200)

GRILLE RETAINER
GM "J" BODY

PKG: 25

1019



(OE 14013241)

GRILLE RETAINER
GM & UNIVERSAL

PKG: 25

1044



(OE 0883583)
(OE 9818648)

DOOR PANEL
GM & UNIVERSAL

PKG: 40

1045



(OE 9685057)
(OE 6003349)

DOOR PANEL
GM & CHRYSLER

PKG: 50

1046

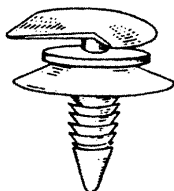

(OE 3065575)

DOOR PANEL
FASTENER
GM & UNIVERSAL

PKG: 25

1047



(OE 20451401)
TRIM RETAINER
GM "C" BODY

PKG: 25

1048



(OE 20421800)

DOOR PANEL
FASTENER
GM 1983-on

PKG: 25

1994



(OE N801925S)
(OE N802900)

DOOR PANEL CLIP
FORD & UNIVERSAL

PKG: 25

1995



(OE 6503204)

DOOR PANEL CLIP
CHRYSLER

PKG: 25

1996



(OE 6505918AA)

DOOR PANEL CLIP
CHRYSLER

PKG: 20

1049

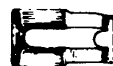

(OE 4234830)

DOOR LOCK CLIP
GM CARS
GENERAL USE

PKG: 25

1050



INSIDE DOOR HANDLE
RETAINING CLIP
GM & FORD

PKG: 50



BODY SHOP FASTENERS

MOULDING BOLTS AND CLIPS

1087



T-BOLT
10-24 x 3/4"

PKG: 10

1088

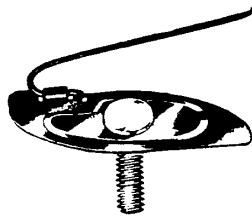

T-BOLT
10-24 x 3/4"

PKG: 15

1089

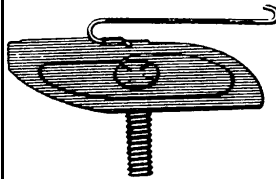

T-BOLT
10-24 x 5/8"

PKG: 10

1091

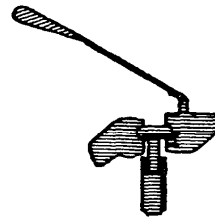

PUSH-IN MOULDING
CLIP - UNIVERSAL

PKG: 15

1489



10-24 HEX NUT
PLATED

PKG: 100

1490



10-24 HEX WASHER
HEAD "GRIP-LOCK" NUT

PKG: 50

1092

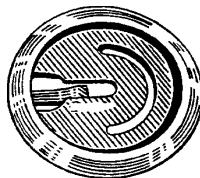

(OE 22506785)
ROCKER PANEL
CLIP - GM

PKG: 25

1093



(OE 8799350)
QUARTER & BELT
MOULDING CLIP - GM

PKG: 50

1094



(OE 20274997)
REAR QUARTER
MOULDING CLIP - GM

PKG: 50

1095



(OE 20315425)
MOULDING CLIP - GM

PKG: 25

1096



(OE 20199675)
MOULDING CLIP - GM

PKG: 50

1097



(OE 20175051)
MOULDING CLIP - GM
(WIDER THAN #1096)

PKG: 25

1098



(OE 9808241)
WINDOW REVEAL
MOULDING CLIP - GM

PKG: 25

1099



(OE 9662950)
WINDOW REVEAL
MOULDING CLIP - GM

PKG: 50

1100



(OE E35B-6342413AB)
WINDOW REVEAL
MOULDING - FORD

PKG: 25

1101



(OE D1AB-6542413-AB)
WINDOW REVEAL
MOULDING - FORD

PKG: 25

1102



(OE 9731301)
WINDSHIELD REVEAL
MOULDING CLIP
PLASTIC - GM

PKG: 25

1104

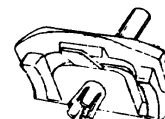















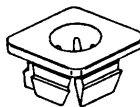
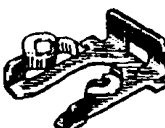

(OE 20113224)
WINDSHIELD REVEAL
MOULDING CLIP
PLASTIC - GM

PKG: 25

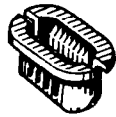

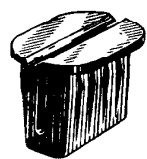
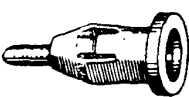







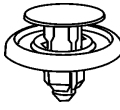



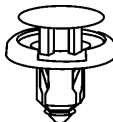

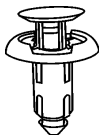

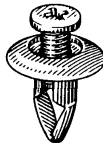

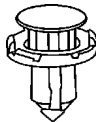
PLASTIC SCREW AND GRILLE NUTS

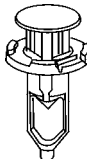



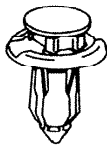















<p>1062</p>  <p>(OE 90189-04022) (OE MS-48001) GRILLE NUT JAPANESE IMPORTS</p> <p>PKG: 50</p>	<p>1063</p>  <p>(OE 379830-5) PLASTIC NUT FORD</p> <p>PKG: 50</p>	<p>1064</p>  <p>(OE 6010082) PLASTIC NUT CHRYSLER & UNIV</p> <p>PKG: 50</p>	<p>1065</p>  <p>(OE N8005035) NUT - FRONT FENDER & DASH - FORD</p> <p>PKG: 50</p>	<p>1066</p>  <p>(OE 25501771) METAL SCREW RETAINER - GM</p> <p>PKG: 25</p>
<p>1067</p>  <p>(OE 14013246) PLASTIC HEADLAMP NUT - GM</p> <p>PKG: 50</p>	<p>1068</p>  <p>(OE 3893980) PLASTIC SCREW NUT GM & UNIVERSAL</p> <p>PKG: 50</p>	<p>1666</p>  <p>(OE 22514578) PARKING LAMP ASSEMBLY NUT GM & UNIVERSAL</p> <p>PKG: 20</p>	<p>1069</p>  <p>PLASTIC NUT GM, FORD & UNIV</p> <p>PKG: 50</p>	<p>1070</p>  <p>(OE 6031138) (OE 6031234) PLASTIC NUT CHRYSLER</p> <p>PKG: 25</p>
<p>1071</p>  <p>(OE 390744) LICENSE PLATE NUT - UNIVERSAL</p> <p>PKG: 50...250...500</p>		<p>1673</p>  <p>(OE E9DB-13N020AA) HEADLAMP RETAINING CLIP - FORD</p> <p>PKG: 15</p>	<p>1072</p>  <p>(OE 3986978) HEADLAMP BEZEL NUT - GM</p> <p>PKG: 25</p>	<p>1073</p>  <p>(OE 25525798) GRILLE RETAINING GROMMET - GM</p> <p>PKG: 25</p>
<p>1074</p>  <p>(OE 1377030) HEADLAMP BEZEL NUT - GM</p> <p>PKG: 25</p>	<p>1075</p>  <p>(OE 25508532) (OE 1264963) PLASTIC GRILLE NUT GM & FORD</p> <p>PKG: 25</p>	<p>1077</p>  <p>(OE 412219) HEADLAMP DOOR NUT - GM</p> <p>PKG: 25</p>	<p>1078</p>  <p>(OE 152807) HEADLAMP SPACER CHRYSLER & UNIV</p> <p>PKG: 25</p>	<p>1079</p>  <p>(OE 10004329) HEADLAMP NUT GM & UNIVERSAL</p> <p>PKG: 15</p>

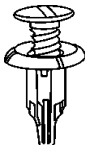

IMPORT FASTENERS























<p>1967</p>  <p>(OE 90467-10183) TOYOTA - 7mm HOLE STEM: 7.5mm, HEAD: 18mm PKG: 10...50...100</p>	<p>1747</p>  <p>(OE 90467-07166) TOYOTA - 7mm HOLE STEM: 8mm, HEAD: 20mm PKG: 10...50...100</p>	<p>1983</p>  <p>(OE 90467-07201) TOYOTA - 7mm HOLE STEM: 10mm, HEAD: 20mm PKG: 10...50...100</p>	<p>2026</p>  <p>(OE 90467-07211) TOYOTA - 7mm HOLE STEM: 8mm, HEAD: 19mm PKG: 10...50...100</p>	
<p>1896</p>  <p>(OE 01553-09321) NISSAN - 8mm HOLE STEM: 9mm, HEAD: 20mm PKG: 10...50...100</p>	<p>1745</p>  <p>(OE 91512-SX0-003) HONDA - 8mm HOLE STEM: 11mm, HEAD: 20mm PKG: 20...100...200</p>	<p>1746</p>  <p>(OE 01553-09611) NISSAN - 8mm HOLE STEM: 12mm, HEAD: 18mm PKG: 10...50...100</p>	<p>1968</p>  <p>(OE 11296-AG000) NISSAN - 8mm HOLE STEM: 13mm, HEAD: 20mm PKG: 10...50...100</p>	<p>2025</p>  <p>(OE 91501-SO4-003) HONDA - 8mm HOLE STEM: 10mm, HEAD: 20mm PKG: 10...50...100</p>
<p>1752</p>  <p>(OE 90505-SX0-003) HONDA - 8mm HOLE STEM: 15mm, HEAD: 18mm PKG: 10...50...100</p>	<p>1590</p>  <p>(OE 6384401A00) NISSAN - 8mm HOLE STEM: 18mm, HEAD: 20mm PKG: 20...100...200</p>	<p>1893</p>  <p>(OE 63878-01E10) NISSAN - 8mm HOLE STEM: 22mm, HEAD: 20mm PKG: 10</p>	<p>2080</p>  <p>(OE 91501-TRO-003) HONDA - 8mm HOLE STEM: 10mm, HEAD: 20mm PKG: 10...50...100</p>	
<p>1748</p>  <p>(OE MR-200300) HONDA - 9mm HOLE STEM: 12mm, HEAD: 18mm PKG: 10...50...100</p>	<p>1749</p>  <p>(OE 63848-9E001) NISSAN - 9mm HOLE STEM: 22mm, HEAD: 18mm PKG: 10...50...100</p>	<p>1740</p>  <p>(OE 52161-16010) TOYOTA - 9mm HOLE STEM: 28mm, HEAD: 18mm PKG: 10...50...100</p>	<p>1975</p>  <p>(OE 52161-20010) TOYOTA - 9mm HOLE STEM: 31mm, HEAD: 18mm PKG: 10...50...100</p>	
<p>1984</p>  <p>(OE 91503-S0K-A01) HONDA - 10mm HOLE STEM: 14mm, HEAD: 20mm PKG: 10...50...100</p>	<p>1971</p>  <p>(OE 91505-S9A-003) HONDA - 10mm HOLE STEM: 13mm, HEAD: 20mm METAL INSERT PKG: 10...50...100</p>	<p>1969</p>  <p>(OE 01553-09241) NISSAN - 10mm HOLE STEM: 15mm, HEAD: 18mm PKG: 10...50...100</p>	<p>1695</p>  <p>(OE 91503-SZ3-003) HONDA - 10mm HOLE STEM: 13mm, HEAD: 20mm PKG: 10...50...100</p>	<p>1719</p>  <p>(OE 91503-SZ5-003) HONDA - 10mm HOLE STEM: 17mm, HEAD: 20mm PKG: 10...50...100</p>

IMPORT FASTENERS

<p>2068</p>  <p>(OE 90467-05090-B1) SCREW RIVET TOYOTA - 5mm HOLE PKG: 10</p>	<p>1579</p>  <p>(OE 90684-SA5-0030) SCREW RETAINER HONDA - 6mm HOLE PKG: 20...100...200</p>	<p>1580</p>  <p>(OE 1395-68-676) SCREW RETAINER NISS/MAZ - 6mm HOLE PKG: 10</p>	<p>1581</p>  <p>(OE 90668-SB0-003) SCREW RETAINER HONDA - 6mm HOLE PKG: 20</p>	
<p>1583</p>  <p>(OE 90657-SA6-0030) SCREW RETAINER HONDA - 7mm HOLE PKG: 15</p>	<p>1582</p>  <p>(OE 90467-06017) SCREW RETAINER TOYOTA - 7mm HOLE PKG: 15</p>		<p>1979</p>  <p>(OE B092-51-833) SCREW RIVET MAZDA - 8mm HOLE PKG: 10...50...100</p>	<p>1660</p>  <p>(OE 90675-SB0-003) PLASTIC SCREW RIVET 8mm HOLE; 20mm DIA. HONDA/MAZDA/NISSAN PKG: 20...100...200</p>
<p>1980</p>  <p>(OE BC1D-56-145) SCREW RIVET MAZDA - 8mm HOLE PKG: 10</p>	<p>1696</p>  <p>(OE 91512-SM4-003) SPLASH SHIELD CLIP HONDA - 8mm HOLE PKG: 15...75...150</p>	<p>1717</p>  <p>(OE 90467-09145) BUMPER COVER RIVET TOYOTA - 9mm HOLE PKG: 10</p>	<p>1981</p>  <p>(OE 90467-09166) TOYOTA RETAINER 9mm SQUARE HOLE PKG: 10</p>	<p>1697</p>  <p>(OE 91503-SP0-0030) BUMPER RETAINER HONDA/ACURA - 10mm PKG: 10...50...100</p>
			<p>1658</p>  <p>(OE 90505-SM4-003) SCREW-TYPE RETAINER HONDA - 8mm HOLE PKG: 10</p>	<p>1751</p>  <p>(OE 91561-S84-A00-M1) SCREW-TYPE RETAINER HONDA - 8mm HOLE PKG: 10</p>
<p>1693</p>  <p>(OE 90467-09093) BUMPER RETAINER LEXUS - 9mm HOLE PKG: 10</p>	<p>1694</p>  <p>(OE 90467-09143) SCREW RETAINER LEXUS - 9mm HOLE PKG: 10</p>	<p>1594</p>  <p>(OE 91504-SM4-000) SCREW-TYPE RIVET HONDA - 10mm HOLE PKG: 10</p>	<p>1597</p>  <p>(OE 91502-SM4-000) SCREW-TYPE RIVET HONDA - 10mm HOLE PKG: 10</p>	<p>1664</p>  <p>(OE 91502-SP0-003) BUMPER RETAINER HONDA - 10mm HOLE PKG: 10</p>













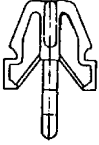
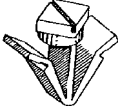
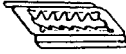

IMPORT FASTENERS

<p>2031</p>  <p>(OE BP4K-58-762) RETAINING CLIP MAZDA/HONDA - 4mm PKG: 20...100...200</p>	<p>1605</p>  <p>(OE 9924-90-512B) RETAINING CLIP NISSAN - 4mm HOLE PKG: 20</p>	<p>1606</p>  <p>(OE 0155300211) TRIM CLIP - 6mm HOLE NISSAN & TOYOTA PKG: 20...100...200</p>	<p>2082</p>  <p>(OE 91518-S10-003) RETAINING CLIP HONDA - 5mm HOLE PKG: 20...100...200</p>	<p>1700</p>  <p>(OE 91518-SM4-003) RETAINING CLIP 6mm HOLE HONDA & ACURA PKG: 20...100...200</p>
<p>1701</p>  <p>(OE 91520-SM4-C010) HOOD INSULATION CLIP - 6mm HOLE HONDA & ACURA PKG: 20...100...200</p>	<p>1603</p>  <p>(OE 67868-89101) PLASTIC CLIP TOYOTA - 5mm HOLE PKG: 20</p>	<p>1602</p>  <p>(OE 90664-671-0030) WEATHERSTRIP CLIP 5mm HOLE NISSAN & HONDA PKG: 20</p>	<p>1706</p>  <p>(OE 91568-SR2-003) WEATHERSTRIP CLIP HONDA - 5mm HOLE PKG: 50...250...500</p>	<p>1707</p>  <p>(OE 91530-SP1-003) WEATHERSTRIP CLIP HONDA - 6mm HOLE PKG: 25...125...250</p>
<p>1921</p>  <p>(OE 65810-K2000) HOOD SEAL RETAINER NISSAN - 5mm HOLE PKG: 20</p>	<p>1607</p>  <p>(OE 66435-648-0000) RETAINING CLIP HONDA - 5mm HOLE PKG: 20</p>	<p>1698</p>  <p>NYLON RETAINER HONDA - 5mm HOLE PKG: 25</p>	<p>1618</p>  <p>(OE 90666-SAO-0030) RETAINING CLIP 5mm HOLE PKG: 20</p>	<p>1609</p>  <p>(OE 01553-00291) RETAINING CLIP NISSAN/MAZDA - 5.5mm PKG: 20</p>
<p>1702</p>  <p>(OE 91501-SM4-003) RETAINING CLIP HONDA - 6mm HOLE PKG: 15</p>				<p>2065</p>  <p>(OE 90467-07076-CO) BUMPER RETAINER TOYOTA - 6.3mm HOLE PKG: 15</p>
<p>2066</p>  <p>(OE 90467-07117) PUSH RIVET TOYOTA/LEXUS - 7mm PKG: 10</p>	<p>2067</p>  <p>(OE 90467-07043) PUSH RIVET NISSAN/TOYOTA - 7mm PKG: 15</p>	<p>1742</p>  <p>(91545-SE0-0030-W1) PUSH-TYPE RETAINER HONDA/NISSAN - 8mm PKG: 10...50...100</p>	<p>1982</p>  <p>(OE 91505-ST7-003ZA) PUSH-TYPE RETAINER HONDA - 8mm HOLE PKG: 10</p>	<p>1663</p>  <p>(OE 01553-06721) BUMPER RETAINER NISSAN - 8mm HOLE PKG: 15...75...150</p>

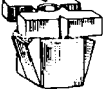



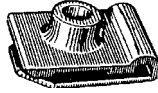
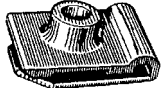















IMPORT FASTENERS

<p>1667</p>  <p>(OE 90189-06013) GROMMET - TOY/LEX 6mm SCREW - 8mm HOLE PKG: 20...100...200</p>	<p>1917</p>  <p>(OE 90189-06157) GROMMET - TOY/LEX #12 SCREW - 8mm HOLE PKG: 15...75...150</p>	<p>1988</p>  <p>(OE 90189-06028) GROMMET - TOY/LEX #12 SCREW - 9mm HOLE PKG: 10...50...100</p>	<p>1989</p>  <p>(OE 90682-SEA-003) FENDER GROMMET 9mm HOLE - HONDA PKG: 20...100...200</p>	<p>1598</p>  <p>(OE 90676-671-0030) TRIM FASTENER HONDA PKG: 20</p>
<p>1558</p>  <p>(OE 90467-13008) GRILLE CLIP TOYOTA PKG: 20</p>	<p>1559</p>  <p>(OE 58974-00008) GRILLE CLIP MITSUBISHI & ISUZU PKG: 20</p>	<p>1563</p>  <p>(OE 62318-H8500) GRILLE CLIP NISSAN - BLACK PKG: 10</p>	<p>1577</p>  <p>(OE 90468-04030) BUMPER STRIP RETAINER - TOYOTA PKG: 20</p>	<p>1578</p>  <p>(OE 90183-03001) FRONT BUMPER CUSHION - TOYOTA PKG: 20</p>
<p>1548</p>  <p>(OE 90189-04008) GRILLE NUT TOYOTA & MITSUBISHI PKG: 20</p>				
<p>2069</p>  <p>(OE 63848-35F00) NYLON "U" NUT 4.8mm - BLACK PKG: 10</p>	<p>1574</p>  <p>(OE 53789-14010-A) NYLON "U" NUT 5mm - TOYOTA PKG: 10</p>	<p>2070</p>  <p>(OE 90467-05114) NYLON "U" NUT 5.5mm - BLACK PKG: 10</p>	<p>1575</p>  <p>(OE 53879-22010) NYLON "U" NUT 6mm - BLACK PKG: 15</p>	<p>1576</p>  <p>(OE 53879-10010) NYLON "U" NUT 6mm - BLACK PKG: 10</p>

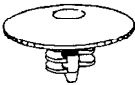



IMPORT FASTENERS



<p>1920</p>  <p>(OE 9991-00-601) (OE 91619-SA5-003) #10 SCREW GROMMET TOYOTA/HONDA/MAZDA PKG: 20...100...200</p>	<p>1901</p>  <p>(OE 90662-671-0030) (OE 6825-H5000) #10 SCREW GROMMET TOYOTA/HONDA/NISSAN PKG: 25</p>	<p>2087</p>  <p>(OE 90189-06193) #12 SCREW GROMMET TOYOTA/LEXUS PKG: 20</p>	<p>1900</p>  <p>(OE 96706-H9400) (OE 90686-SB0-003) #4 SCREW GROMMET TOYOTA/HONDA/NISSAN PKG: 20</p>	<p>1899</p>  <p>(OE 90189-04013) #5 SCREW GROMMET TOYOTA & NISSAN PKG: 25...125...250</p>
<p>1898</p>  <p>(OE 90661-SC7-0030) (OE 90189-06001) #8 SCREW GROMMET TOYOTA/HONDA/NISSAN PKG: 20</p>	<p>1902</p>  <p>(OE 96706-U0100) (OE 90686-SB0-003) #10 SCREW GROMMET TOYOTA/MITSU/NISSAN PKG: 20...100...200</p>			
<p>1991</p>  <p>(OE 91560-S84A-A01) DOOR PANEL CLIP 8mm HOLE - HONDA PKG: 20</p>	<p>1992</p>  <p>(OE 90467-10188) DOOR PANEL CLIP 8.5mm HOLE - TOYOTA PKG: 20</p>	<p>1993</p>  <p>(OE 90467-A0005) DOOR PANEL CLIP 8.5mm HOLE - TOY/LEX PKG: 10</p>	<p>1990</p>  <p>(OE 6771-12050) DOOR PANEL CLIP 9mm HOLE - TOY/LEX PKG: 25...125...250</p>	<p>1567</p>  <p>(OE 01553-5-3500) TRIM PANEL RETAINER NISSAN PKG: 20</p>
<p>1568</p>  <p>(OE 9927-40-821) DOOR PANEL JAPANESE IMPORTS PKG: 20</p>	<p>1569</p>  <p>(OE 9927-40-825) DOOR PANEL ISUZU & TOYOTA PKG: 20</p>			<p>1987</p>  <p>(OE 90467-09050) (OE 90467-A0003) HOOD INSUL CLIP LEX/TOY - 7mm HOLE PKG: 10...50...100</p>
<p>1591</p>  <p>(OE G030-68-885-B-38) HOOD RETAINING CLIP MAZDA PKG: 20</p>	<p>1916</p>  <p>(OE 91501-S1K-0030) HOOD INSUL CLIP HONDA/ACURA - 7mm PKG: 20...100...200</p>	<p>1592</p>  <p>(OE 65832-F5000) HOOD INSULATION CLIP - NISSAN PKG: 20</p>	<p>1593</p>  <p>(OE 90467-9008) RETAINING CLIP JAPANESE IMPORTS PKG: 20</p>	<p>2083</p>  <p>(OE 90501-SWA-003) HOOD INSULATION CLIP - HONDA PKG: 20...100...200</p>

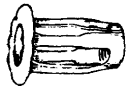











SPECIALTY MOUNTING FASTENERS

 JACK NUTS				 WELL NUTS <i>(NEOPRENE WITH CAPTIVE BRASS NUT)</i>				
BSF PART NO.	THREAD SIZE	FINISH	PKG	BSF PART NO.	THREAD SIZE	HOLE SIZE	OVERALL LENGTH	PKG
1301	1/4-20	Zinc	10	1946	1/4-20	1/2	.641	10
1941	1/4-20 (Long)	Zinc	10	1947	1/4-20	1/2	.829	10
1942	1/4-20	Zinc w/ Sealer	10	1948	5mm	3/8	.665	10
1943	5mm	Zinc w/ Sealer	10	1949	6mm	1/2	.630	10
1944	6mm	Zinc	10	1950	6mm	1/2	.829	10
1945	6mm	Zinc w/ Sealer	10					

SPECIALTY MOUNTING SCREWS











<p>1951</p>  <p>5 x 26mm - PHILLIPS OVAL HEAD MACHINE SCREW - STAINLESS STEEL</p> <p>PKG: 10</p>	<p>1302</p>  <p>1/4-20 x 1" HEX WASHER HEAD MACHINE SCREW - ZINC</p> <p>PKG: 25</p>	<p>1952</p>  <p>1/4-20 x 7/8" HEX WASHER HEAD SCREW BLACK - GM & UNIVERSAL</p> <p>PKG: 10</p>	<p>1953</p>  <p>1/4-20 x 1-1/4" HEX WASHER HEAD SCREW STAINLESS STEEL - UNIV</p> <p>PKG: 10</p>
<p>1938</p>  <p>6 - 1.0 x 20mm HEX-SLOTTED WASHER HEAD SCREW - ZINC</p> <p>PKG: 25</p>	<p>1954</p>  <p>6 x 26mm TORX DRIVE - PAN HEAD MACHINE SCREW - CHROME PLATED w/ WASHER</p> <p>PKG: 10</p>	<p>1955</p>  <p>6 x 26mm PHILLIPS OVAL HEAD MACHINE SCREW STAINLESS STEEL</p> <p>PKG: 10</p>	

BARREL CLIPS



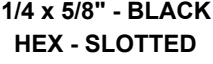







<p>1303</p>  <p>3/32" STUD</p> <p>PKG: 100</p>	<p>1304</p>  <p>1/8" STUD</p> <p>PKG: 100</p>	<p>1305</p>  <p>1/8" STUD</p> <p>PKG: 100</p>	<p>1306</p>  <p>1/8" w/ SEALER</p> <p>PKG: 50</p>	<p>1307</p>  <p>3/16" STUD</p> <p>PKG: 50</p>
<p>1308</p>  <p>3/16" STUD</p> <p>PKG: 50</p>	<p>1309</p>  <p>3/16" STUD</p> <p>PKG: 50</p>	<p>1311</p>  <p>1/8" PLASTIC</p> <p>PKG: 100</p>	<p>1312</p>  <p>3/16" PLASTIC</p> <p>PKG: 50</p>	



LICENSE PLATE FASTENERS

<p>1071</p>  <p>PLASTIC LICENSE PLATE NUT PKG: 50...250...500</p>	<p>1299</p>  <p>1/4 x 3/4" - ZINC HEX - SLOTTED PKG: 50...250...500</p>	<p>2089</p>  <p>1/4 x 3/4" - ZINC HEX - PHILLIPS PKG: 40...200...400</p>	<p>1298</p>  <p>1/4 x 5/8" - ZINC ROUND - SLOTTED PKG: 50...250...500</p>	<p>1922</p>  <p>6 x 20mm - GOLD HEX - PHILLIPS PKG: 50...200</p>	<p>1939</p>  <p>1/4 x 3/4" - HEX BLACK E-COAT PKG: 25...100</p>
<p>1936</p>  <p>1/4 x 5/8" - BLACK HEX - SLOTTED PKG: 25</p>	<p>2010</p>  <p>14 x 1/2" - ZINC THUMB SCREW PKG: 15...50</p>		<p>1711</p>  <p>6mm HEX FLANGE NUT PKG: 25...125...250</p>	<p>1300</p>  <p>1/4" - 20 x 1/2" ROUND - SLOTTED WITH HEX NUT PKG: 50</p>	<p>1940</p>  <p>1/4" - 20 x 5/8" BLACK NYLON SLOTTED TRUSS HEAD WITH NUT PKG: 15</p>

METRIC LICENSE PLATE

	<p>2030</p>  <p>6 x 16mm - ZINC ROUND - SLOTTED PKG: 50...200</p>	<p>1937</p>  <p>6x16mm - SLOTTED BLACK E-COAT PKG: 25...125...250</p>	<p>2027</p>  <p>6 x 20mm - GOLD PHILLIPS PAN HD PKG: 50...200</p>	<p>2028</p>  <p>6x20mm - PHILLIPS BLACK E-COAT PKG: 50...200</p>	<p>2029</p>  <p>6 x 20mm - ZINC PHILLIPS PAN HD PKG: 50...200</p>
<p>2075</p>  <p>5 x 8mm - ZINC PHILLIPS PAN HD PKG: 50...200</p>	<p>2076</p>  <p>5 x 10mm - ZINC PHILLIPS PAN HD PKG: 50...200</p>	<p>2024</p>  <p>5 x 16mm - ZINC PHILLIPS PAN HD PKG: 50...200</p>	<p>2077</p>  <p>6 x 10mm - ZINC PHILLIPS PAN HD PKG: 50...200</p>	<p>2078</p>  <p>6 x 12mm - ZINC PHILLIPS PAN HD PKG: 50...200</p>	<p>2079</p>  <p>6 x 16mm - ZINC PHILLIPS PAN HD PKG: 50...200</p>



METRIC BODY BOLTS AND NUTS

1107

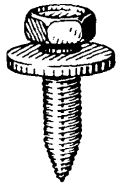

(OE 11503834)
**6 x 25mm BODY BOLT
 w/ LOOSE WASHER**
 PKG: 25...125...250

1712

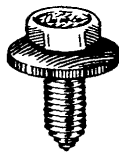

(OE 11502941, 11506174)
**6 x 20mm BODY BOLT
 w/ LOOSE WASHER**
 PKG: 25...125...250

1678



(OE 11505044)
**6 x 35mm BODY BOLT
 w/ LOOSE WASHER**
 PKG: 20...100...200

1108

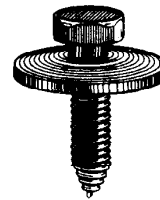

(OE 11504493)
**6 x 25mm BODY BOLT
 w/ LARGE WASHER**
 PKG: 25...125...250

1897

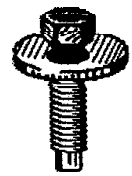

(OE 11501188)
**6 x 28mm BODY BOLT
 ZINC/YELLOW PLATED**
 PKG: 20

1110

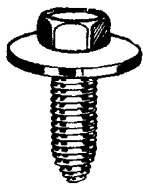

(OE 11501188)
**8 x 30mm BODY BOLT
 w/ LOOSE WASHER**
 PKG: 20...100...200

1111

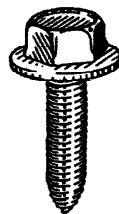

(OE 11500970)
**8 x 25mm BODY BOLT
 HEX WASHER HEAD**
 PKG: 20...100...200

1112

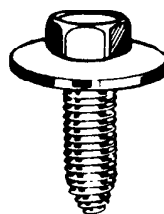

(OE 11501193)
**10 x 40mm BODY BOLT
 WITH LOOSE WASHER**
 PKG: 12...60...120

2011



(OE 10060375)
**5 x 16mm BODY BOLT
 WITH LOOSE WASHER**
 PKG: 20

1918

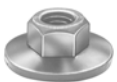

(OE N621901-S36)
**4mm NUT WITH
 6mm WASHER - 9mm HE**
 PKG: 20

1113



(OE 11502702)
**5mm HEX
 FLANGE NUT**
 PKG: 50

1114



(OE 11503752)
**6mm HEX NUT WITH
 16mm LOOSE WASHER**
 PKG: 25...125...250

1687



(OE 11503754, 6100049)
**6mm HEX NUT WITH
 19mm LOOSE WASHER**
 PKG: 25...125...250

1711



(OE 11503745)
**6mm HEX
 FLANGE NUT**
 PKG: 25...125...250

1116



(OE 6500165)
**8mm HEX
 FLANGE NUT**
 PKG: 25...125...250

1117

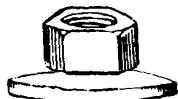

(OE 11500401)
**8mm HEX NUT WITH
 FREE SPINNING
 WASHER**
 PKG: 20...100...200

1118

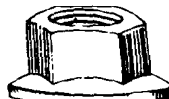

(OE 11501850)
**10mm HEX
 FLANGE NUT**
 PKG: 20...100...200



METRIC CLIPS - RETAINERS - SPEED NUTS

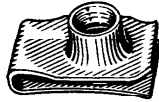

METRIC "U" TYPE SPEED NUTS

BSF PART NO.	SIZE		PKG
1119	6mm	SHORT	25 - 125 - 250
1120	6mm	LONG	25 - 125 - 250
1122	8mm	SHORT	20 - 100 - 200
1123	8mm	LONG	20 - 100 - 200
1124	10mm		12 - 60 - 120



METRIC THREAD CUTTING NUTS

BSF PART NO.	SIZE	PKG
1166	3.2mm	25
1167	4.0mm	50
1168	5.0mm	50
1169	6.3mm	50

1170



SELF THREADING NUT 5/16" STUD SIZE GENERAL PURPOSE

PKG: 25

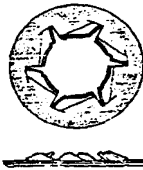

METRIC PUSH - NUT BOLT RETAINERS

BSF PART NO.	SIZE	PKG
1160	6.3mm	50
1161	8mm	50
1162	10mm	50
1163	12mm	50

1105



(OE 10005510)
**METAL CLIP - GM PRODUCTS
BUMPER IMPACT STRIP**

PKG: 50

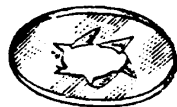

"LARGE FLANGE" PUSH NUT BOLT RETAINERS

BSF PART NO.	SIZE	PKG
1164	8mm	50
1165	10mm	50

1106



(OE 1241972)
**BUMPER IMPACT STRIP FASTENER
GM PRODUCTS**

PKG: 25

"The Professional's Choice"



MISCELLANEOUS BODY HARDWARE

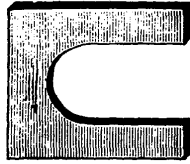

BODY SHIMS - PLATED

BSF PART NO.	THICKNESS	PKG
1314.....	1/16" (3/8" slot).....	25
1315.....	1/8" (3/8" slot).....	25
1316.....	3/16" (5/8" slot).....	20

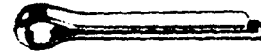

COTTER PINS "PLATED"

BSF PART NO.	SIZE	PKG
1320.....	3/32 x 1".....	100
1764.....	1/8 x 1-1/2".....	100
1321.....	1/8 x 2".....	100
1322.....	5/32 x 2".....	100

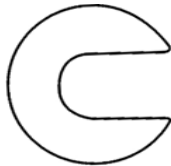

BODY SHIMS - C-TYPE

BSF PART NO.	SIZE	PKG
1914.....	1/16" (3/8" slot).....	25
1915.....	1/8" (3/8" slot).....	25



NUTSERTS

BSF PART NO.	SIZE	PKG
1323.....	10-24.....	25
1324.....	1/4-20.....	20
1325.....	5/16-18.....	10



FENDER WASHERS

BSF PART NO.	SIZE	PKG
1317.....	1/4 x 1-1/4".....	25
1318.....	5/16 x 1-1/2".....	25
1319.....	3/8 x 1-1/4".....	50

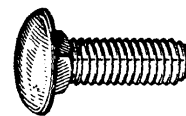

BUMPER BOLTS

BSF PART NO.	SIZE	PKG
1326.....	5/16 x 3/4".....	10
1327.....	3/8 x 1".....	10
1328.....	7/16 x 1-1/2".....	10
1329.....	1/2 x 1-1/2".....	10
1674.....	8 x 25 mm.....	10



SHEET METAL SCREWS



PHILLIPS OVAL HEAD SCREWS BRIGHT ZINC PLATED

BSF PART NO.	SIZE	PKG
1171	8 x 1/2"..... (6 Hd)	100
1172	8 x 3/4"..... (6 Hd)	100
1173	8 x 3/4".....	100
1174	8 x 1"..... (6 Hd)	100
1175	8 x 1".....	100
1176	8 x 1-1/4"..... (6 Hd)	100
1177	8 x 1-1/4".....	100
1178	8 x 1-1/2"..... (6 Hd)	50
1179	8 x 1-1/2".....	50
1183	8 x 2"..... (6 Hd)	50
1184	8 x 2-1/2"..... (6 Hd)	25
1194	10 x 3/4"..... (6 Hd)	50
1195	10 x 1".....	50
1196	10 x 1"..... (6 Hd)	50
1199	10 x 1-1/2".....	50

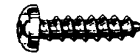

PHILLIPS PAN HEAD SCREWS BRIGHT ZINC PLATED

BSF PART NO.	SIZE	PKG
1216	8 x 1/2".....	100
1217	8 x 3/4".....	100
1218	8 x 1".....	100
1219	10 x 3/4".....	100
1220	10 x 1".....	100



PHILLIPS PAN HEAD SCREWS "BLACK OXIDE"

BSF PART NO.	SIZE	PKG
1230	8 x 1/2"..... <i>BLACK</i>	100
1231	8 x 3/4"..... <i>BLACK</i>	100
1232	8 x 1"..... <i>BLACK</i>	100



PHILLIPS OVAL HEAD SCREWS "BLACK OXIDE"

BSF PART NO.	SIZE	PKG
1210	8 x 3/4"..... (6 Hd)..... <i>BLACK</i>	100
1211	8 x 3/4"..... <i>BLACK</i>	100
1212	8 x 1"..... (6 Hd)..... <i>BLACK</i>	100
1213	8 x 1"..... <i>BLACK</i>	100
1214	8 x 1-1/4"..... (6 Hd)..... <i>BLACK</i>	100
1215	8 x 1-1/4"..... <i>BLACK</i>	100



PHILLIPS OVAL SEMS

BSF PART NO.	SIZE	PKG
1240	8 x 3/4"..... <i>CHROME</i>	50
1241	8 x 1"..... <i>CHROME</i>	50
1250	8 x 3/4"..... <i>BLACK OXIDE</i>	50
1251	8 x 1"..... <i>BLACK OXIDE</i>	50



SHEET METAL SCREWS - TEKS - TORX

SELF DRILLING SCREWS



HEX WASHER HEAD TEKS
"SELF DRILLING"

BSF

PART NO.	SIZE	HEX	PKG
----------	------	-----	-----

1926	8 x 1/2"	1/4"	100
1765	8 x 3/4"	1/4"	100
1766	8 x 1"	1/4"	100
2084	10 x 1/2"	5/16"	50
1679	10 x 3/4"	5/16"	50
1767	10 x 1"	5/16"	50
1680	12 x 3/4"	5/16"	50
1681	14 x 3/4"	3/8"	50



PHILLIPS PAN HEAD TEKS

BSF

PART NO.	SIZE	HEX	PKG
----------	------	-----	-----

2071	8 x 1/2"		100
------	----------	--	-----

1716



(OE 6030539, 9616231)
8 x 1/2" WHEEL OPENING SCREW
"SELF DRILLING"

PKG: 100



PHILLIPS WASHER HEAD TEKS
"SELF DRILLING"

BSF

PART NO.	SIZE	PLATING	PKG
----------	------	---------	-----

1684	8 x 1/2"	BLACK	100
1685	8 x 3/4"	BLACK	50
1686	8 x 1"	BLACK	50

1682



"BLACK FINISH"

4.2 x 20 mm SELF DRILLING SCREW
12mm LOOSE WASHER - 7mm HEX HEAD

PKG: 50

1683

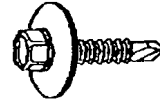

"BLACK FINISH"

4.2 x 20 mm SELF DRILLING SCREW
17mm LOOSE WASHER - 7mm HEX HEAD

PKG: 50



TORX SCREWS



METRIC TORX "OVAL HEAD" SCREWS
STAINLESS STEEL

BSF

PART NO.	SIZE	PLATING	PKG
----------	------	---------	-----

1252	4.2 x 20 mm	CHROME	50
1253	4.2 x 30 mm	CHROME	50
1254	4.2 x 40 mm	CHROME	25
1255	4.2 x 20 mm	BLACK OXIDE	50
1256	4.2 x 30 mm	BLACK OXIDE	50



METRIC TORX "PAN HEAD" SCREWS

















BSF

PART NO.	SIZE	PLATING	PKG
----------	------	---------	-----

1257	4.2 x 20 mm	CHROME	50
1258	4.2 x 35 mm	CHROME	25
1259	4.2 x 20 mm	BLACK	50
1260	4.2 x 25 mm	BLACK	50



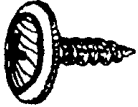
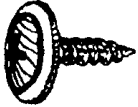
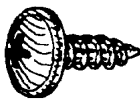













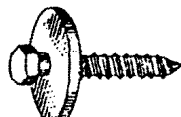

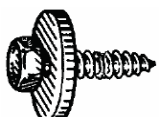
SPECIALTY SCREWS - PHILLIPS

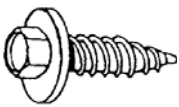
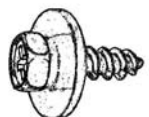
<p>1278</p>  <p>8 x 3/8" (#6 hd) WHEEL OPENING MOULDING SCREW CHROME PLATED</p> <p>PKG: 100...500...1000</p>	<p>1279</p>  <p>(OE 11501903) 8 x 1/2" WHEEL OPENING MOULDING SCREW CHROME PLATED</p> <p>PKG: 100...500...1000</p>	<p>1716</p>  <p>8 x 1/2" WHEEL OPENING "SELF DRILLING" SCREW</p> <p>PKG: 100</p>	<p>1675</p>  <p>4.2 x 16mm PHILLIPS TRUSS HEAD (3/8") BLACK OXIDE</p> <p>PKG: 50...250...500</p>	<p>1676</p>  <p>4.8 x 16mm PHILLIPS TRUSS HEAD (7/16") BLACK OXIDE</p> <p>PKG: 50...250...500</p>
<p>1997</p>  <p>(OE 56902-S2) 8 x 1/2" PHILLIPS FLAT TOP WASHER - BLACK</p> <p>PKG: 100...500...1000</p>	<p>1998</p>  <p>(OE 11505104, 11514970) PHILLIPS WASHER HEAD SCREW - BLACK</p> <p>PKG: 50...250...500</p>	<p>2063</p>  <p>4.2 x 20mm PHILLIPS WASHER HEAD - BRIGHT ZINC</p> <p>PKG: 50</p>	<p>1280</p>  <p>(OE 11501884) 4.2 x 20mm PHILLIPS WASHER HEAD SCREW - BLACK</p> <p>PKG: 100...500...1000</p>	
<p>1677</p>  <p>8 x 3/4" BLACK PHILLIPS PAN HEAD LOOSE WASHER</p> <p>PKG: 50</p>	<p>1924</p>  <p>4.2 x 25mm BLACK PHILLIPS PAN HEAD LOOSE WASHER</p> <p>PKG: 25</p>	<p>2000</p>  <p>10 x 3/4" PHILLIPS FLAT TOP WASHER - BLACK</p> <p>PKG: 50...250...500</p>		
<p>1999</p>  <p>5 x 15mm BLACK TRUSS WASHER HEAD</p> <p>PKG: 50...250...500</p>	<p>1715</p>  <p>5 x 16mm BLACK TRUSS w/ LOOSE WASHER</p> <p>PKG: 50...250...500</p>	<p>2088</p> <p>(OE 90114-SE0-000) 5 x 19mm BLACK TRUSS w/ LOOSE WASHER</p> <p>PKG: 25</p>	<p>1714</p>  <p>6.3 x 16mm BLACK TRUSS HEAD</p> <p>PKG: 50...250...500</p>	

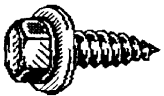

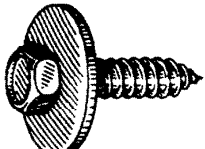
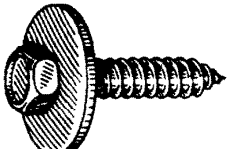
SPECIALTY SCREWS - HEX

<p>1905</p>  <p>4.8 x 17mm "GOLD TONE" HEX WASHER BMW, MERCEDES & UNIVERSAL</p> <p>PKG: 50</p>	<p>1906</p>  <p>4.8 x 17mm "GOLD TONE" LOOSE WASHER BMW, MERCEDES & UNIVERSAL</p> <p>PKG: 25</p>	<p>1907</p>  <p>4.8 x 25mm "GOLD TONE" LOOSE WASHER BMW, MERCEDES & UNIVERSAL</p> <p>PKG: 25</p>	<p>2039</p>  <p>6.3 x 18mm "GOLD TONE" LOOSE WASHER BMW, MERCEDES & UNIVERSAL</p> <p>PKG: 25</p>	
<p>1925</p>  <p>4.2 x 25mm 7mm HEX BLACK W/ LOOSE WASHER (22mm) FORD & UNIVERSAL</p> <p>PKG: 25</p>	<p>1282</p>  <p>(OE 11504056) 4.2 x 20mm 7mm HEX SCREW W/ LOOSE WASHER - BLACK GM PRODUCTS</p> <p>PKG: 100...500...1000</p>	<p>1283</p>  <p>(OE 11503892) 4.2 x 20mm 7mm HEX SCREW W/ LARGE LOOSE WASHER BLACK - GM & UNIV</p> <p>PKG: 50...250...500</p>	<p>2036</p>  <p>4.8 x 25mm 8mm HEX HEAD SCREW</p> <p>PKG: 25</p>	<p>2035</p>  <p>4.8 x 16mm 8mm HEX HEAD SCREW</p> <p>PKG: 25</p>
<p>1281</p>  <p>#10 x 5/8" 5/16" HEAD SHEET METAL SCREW - SLOTTED ZINC PLATED</p> <p>PKG: 100</p>	<p>2037</p>  <p>14 x 7/8" HEX HEAD SCREW SERRATED WASHER</p> <p>PKG: 25</p>	<p>2032</p>  <p>5 x 16mm PHILLIPS HEX SCREW LOOSE WASHER</p> <p>PKG: 25</p>	<p>2033</p>  <p>6.3 x 20mm PHILLIPS HEX SCREW LOOSE WASHER</p> <p>PKG: 25</p>	<p>2034</p>  <p>6.3 x 20mm PHILLIPS HEX SCREW</p> <p>PKG: 25</p>
<p>1284</p>  <p>(OE 1150522) 6.3 x 20mm SHEET METAL SCREW W/ LOOSE WASHER - BLACK GM PRODUCTS</p> <p>PKG: 50...250...500</p>	<p>2038</p>  <p>6.3 x 30mm SHEET METAL SCREW W/ LOOSE WASHER - BLACK</p> <p>PKG: 25</p>	<p>1285</p>  <p>(OE 11507083) 6.3 x 25mm SHEET METAL SCREW W/ LOOSE WASHER - BLACK</p> <p>PKG: 25...125...250</p>	<p>2040</p>  <p>6.3 x 30mm SHEET METAL SCREW W/ LARGE WASHER - BLACK</p> <p>PKG: 25</p>	



HEX SCREWS - SPECIALTY SCREWS



**HEX WASHER HEAD
TAPPING SCREWS**

BSF PART NO.	SIZE	PLATING	PKG
1270.....	14 x 5/8".....	BLACK	50-250-500
1271.....	14 x 3/4".....	ZINC	50
1272.....	5/16 x 7/8".....	BLACK	25



**HEX WASHER HEAD SCREWS
LOOSE WASHER - ZINC**

BSF PART NO.	SIZE	PKG
1273.....	14 x 3/4".....	25
1274.....	14 x 1".....	25
1275.....	5/16 x 1".....	25

1276



#10 x 1-1/2"
REPLACEMENT SCREW FOR
USE WITH SMALL DENT PULLER

PKG: 50

1277



#14 x 2"
3/8" HEAD - FOR USE WITH
LARGE DENT PULLER

PKG: 25

"U" TYPE CLIP NUTS

1290



**#8 SCREW SIZE
"U" TYPE SPEED NUT**

PKG: 50

1291



**#8 SCREW SIZE
"U" TYPE SPEED NUT
GENERAL PURPOSE**

PKG: 50...250...500

1292



(OE 9433155)
**#8 SCREW SIZE (LONG)
"U" TYPE SPEED NUT
GM, FORD & UNIV**

PKG: 50...250...500

1293

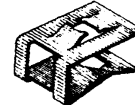

(OE 545920)
**#8 SCREW SIZE
"U" TYPE SPEED NUT
THICK PANEL - GM**

PKG: 25



2001



**#10 SCREW SIZE
"U" TYPE SPEED NUT
GENERAL PURPOSE**

PKG: 25

1294



**#14 SCREW SIZE
"U" TYPE SPEED NUT
GENERAL PURPOSE**

PKG: 50

1295



**1/4" SCREW SIZE
"J" TYPE SPEED NUT
UNIVERSAL**

PKG: 50

1296



**1/4" - 20 SCREW SIZE
"U" TYPE SPEED NUT
UNIVERSAL**

PKG: 50

1297



**5/16" SCREW SIZE
"J" TYPE SPEED NUT
GENERAL PURPOSE**

PKG: 25



USS BOLTS - NUTS - LOCK WASHERS - FLAT WASHERS



GRADE 5



GRADE 8

HEX HEAD CAP SCREWS USS - COARSE THREAD

SIZE	<u>GRADE 5</u> "ZINC PLATED"		<u>GRADE 8</u> "YELLOW ZINC"	
	#	QTY	#	QTY
1/4 x 1/2"	1428	50	1828	50
1/4 x 3/4"	1429	50	1829	50
1/4 x 1"	1430	50	1830	50
1/4 x 1-1/4"	1431	50	1831	25
1/4 x 1-1/2"	1432	50	1832	25
1/4 x 2"	1433	50	1833	25
5/16 x 1/2"	1434	50	1834	50
5/16 x 3/4"	1435	50	1835	50
5/16 x 1"	1436	50	1836	50
5/16 x 1-1/4"	1437	50	1837	25
5/16 x 1-1/2"	1438	25	1838	25
5/16 x 2"	1439	25	1839	25
3/8 x 1/2"	1440	25	1840	25
3/8 x 3/4"	1441	25	1841	25
3/8 x 1"	1442	25	1842	25
3/8 x 1-1/4"	1443	25	1843	25
3/8 x 1-1/2"	1444	25	1844	20
3/8 x 2"	1445	25	1845	20
3/8 x 2-1/2"	1446	20	1846	15
3/8 x 3"	1447	20	1847	15
7/16 x 1"	1448	20	1848	20
7/16 x 1-1/4"	1449	20	1849	20
7/16 x 1-1/2"	1450	20	1850	15
7/16 x 2"	1451	20	1851	15
7/16 x 2-1/2"	1452	15	1852	15
1/2 x 1"	1453	15	1853	15
1/2 x 1-1/2"	1454	15	1854	15
1/2 x 2"	1455	15	1855	10
1/2 x 2-1/2"	1456	10	1856	10
1/2 x 3"	1457	10	1857	10
5/8 X 3"	n/a	-	1884	5
5/8 X 3-1/2"	n/a	-	1885	5
5/8 X 4"	n/a	-	2085	5
5/8 X 4-1/2"	n/a	-	2086	5



HEX NUTS - PLATED

SIZE	<u>STANDARD</u>		<u>GRADE 8</u>	
	#	QTY	#	QTY
1/4" - 20	1458	100	1858	100
5/16" - 18	1459	100	1859	100
3/8" - 16	1460	100	1860	50
7/16" - 14	1461	50	1861	25
1/2" - 13	1462	50	1862	25
5/8"-11	n/a	-	1886	10



LOCK WASHERS - PLATED

SIZE	<u>STANDARD</u>		<u>GRADE 8</u>	
	#	QTY	#	QTY
1/4"	1463	100	1863	100
5/16"	1464	100	1864	100
3/8"	1465	100	1865	50
7/16"	1466	100	1866	50
1/2"	1467	50	1867	25



USS FLAT WASHERS * PLATED *

SIZE	<u>STANDARD</u>		<u>GRADE 8</u>	
	#	QTY	#	QTY
3/16" OR #10	1473	1 LB	-	-
1/4" USS	1468	1 LB	1868	100
5/16" USS	1469	1 LB	1869	50
3/8" USS	1470	1 LB	1870	50
7/16" USS	1471	1 LB	1871	25
1/2" USS	1472	1 LB	1872	25
5/8" USS	n/a	-	1887	10

* SAE FLAT WASHERS *

1/4" SAE	1479	1 LB	1879	100
5/16" SAE	1480	1 LB	1880	50
3/8" SAE	1481	1 LB	1881	50
7/16" SAE	1482	1 LB	1882	25
1/2" SAE	1483	1 LB	1883	25
5/8" SAE	n/a	-	1888	10

* SAE WASHERS HAVE SMALLER O.D. *



METRIC BOLTS - NUTS - WASHERS - LOCK WASHERS

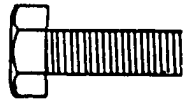

METRIC HEX HEAD CAP SCREWS
COARSE THREAD - DIN 933
GRADE 8.8

BSF

PART NO.	SIZE	PKG
1500.....	4 x 16 mm.....	25
1501.....	4 x 20 mm.....	25
1502.....	5 x 16 mm.....	25
1503.....	5 x 20 mm.....	25
1504.....	5 x 25 mm.....	25
1505.....	6 x 16 mm.....	25
1506.....	6 x 20 mm.....	25
1507.....	6 x 25 mm.....	25
1508.....	6 x 30 mm.....	25
1509.....	6 x 35 mm.....	25
1510.....	6 x 40 mm.....	25
1511.....	6 x 50 mm.....	25
1512.....	8 x 16 mm.....	25
1513.....	8 x 20 mm.....	25
1514.....	8 x 25 mm.....	25
1515.....	8 x 30 mm.....	25
1516.....	8 x 35 mm.....	25
1517.....	8 x 40 mm.....	25
1518.....	8 x 50 mm.....	25
1519.....	10 x 20 mm.....	15
1520.....	10 x 25 mm.....	15
1521.....	10 x 30 mm.....	15
1522.....	10 x 35 mm.....	15
1523.....	10 x 40 mm.....	15
1524.....	10 x 50 mm.....	10
1525.....	12 x 30 mm.....	10
1526.....	12 x 35 mm.....	10
1527.....	12 x 40 mm.....	10
1528.....	12 x 60 mm.....	10



METRIC HEX NUTS - DIN 934

BSF

PART NO.	SIZE	PKG
1530.....	4 mm.....	100
1531.....	5 mm.....	100
1532.....	6 mm.....	100
1533.....	8 x 1.25 mm.....	100
1534.....	10 x 1.5 mm.....	50
1535.....	12 x 1.75 mm.....	25



METRIC LOCK WASHERS

BSF

PART NO.	SIZE	PKG
1536.....	4 mm.....	100
1537.....	5 mm.....	100
1538.....	6 mm.....	100
1539.....	8 mm.....	100
1540.....	10 mm.....	50
1541.....	12 mm.....	50



METRIC FLAT WASHERS

BSF

PART NO.	SIZE	PKG
1542.....	4 mm.....	100
1543.....	5 mm.....	100
1544.....	6 mm.....	100
1545.....	8 mm.....	100
1546.....	10 mm.....	50
1547.....	12 mm.....	50



DOME HEAD RIVETS

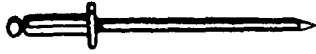

BSF #	DIA	TYPE	GRIP RANGE	PKG
1340 (SB 4-4).....	1/8".....	STEEL.....	1/8-1/4"....	200
1350 (AB 4-4).....	1/8".....	ALUM.....	1/8-1/4"....	200
1929 (AB 4-4).....	1/8".....	ALUM-BLACK...	1/8-1/4"....	100
1341 (SB 4-6).....	1/8".....	STEEL.....	1/4-3/8"....	200
1351 (AB 4-6).....	1/8".....	ALUM.....	1/4-3/8"....	200
1930 (AB 4-6).....	1/8".....	ALUM-BLACK...	1/4-3/8"....	100
1927 (AB 5-4).....	5/32"...	ALUM.....	1/8-1/4"....	100
1928 (AB 5-6).....	5/32"...	ALUM.....	1/4-3/8"....	100
1355 (AB 6-4).....	3/16"...	ALUM.....	1/8-1/4"....	100
1356 (AB 6-6).....	3/16"...	ALUM.....	1/4-3/8"....	100



BSF #	DIA	TYPE	PKG
1342 (AB 4-3).....	1/8".....	ALUM.....	100

* SPECIAL "SMALL FLANGE" MOULDING CLIP RIVET *



RIVET WASHERS

BSF #	SIZE	TYPE	PKG
1367	1/8".....	STEEL.....	250
1368	3/16".....	STEEL.....	250



LARGE FLANGE RIVETS

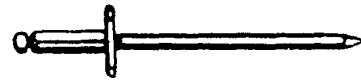

BSF #	DIA	TYPE	GRIP RANGE	PKG
1718 (ABL 4-4).....	1/8".....	ALUM.....	1/8-1/4".....	100
1895 (SBL 4-4).....	1/8".....	STEEL.....	1/8-1/4".....	100



BSF #	DIA	TYPE	GRIP RANGE	PKG
1357 (ABL 6-6).....	3/16"...	ALUM.....	1/4-3/8".....	50

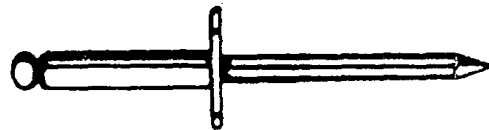

BSF #	DIA	TYPE	GRIP RANGE	PKG
1358 (ABL 6-10).....	3/16"...	ALUM.....	1/2-5/8".....	50



1/4" SPLIT RIVET - WINDOW REG. DOOR HANDLE

1363 - PKG - 25 / 100 / 200



1/4" "GLASS STOP" PEEL RIVET

1365 - PKG - 25 / 100 / 200



SPECIAL APPLICATION RIVETS

1360



(OE 9432137)
**SWIVEL EMBLEM - SEALED END
 TRUNK LOCK RIVET**
 PKG: 25

1670



(OE 388664-S100)
**3/16" RIVET - GRILLE RETAINING
 9/16" FLANGE - FORD PRODUCTS**
 PKG: 25...125...250

1668



(OE N805759-S100)
**1/8" ALUMINUM RIVET - BLACK
 3/8" FLANGE - .063-.125" GRIP - FORD PRODUCTS**
 PKG: 50...250...500

1361

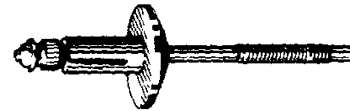

(OE 388442-5100)
**1/4" DIA. SPECIAL RIVET - BLACK
 FORD BUMPER ASSEMBLY**
 PKG: 20...100...200

1933



(OE N900-845-01)
**5/32" RIVET - 1/4-3/8" GRIP
 BLACK ALUMINUM RIVET - STEEL MANDREL**
 PKG: 20...100...200

1671



(OE N806830-S100)
**1/4" ALUMINUM RIVET - BLACK - BUMPER COVER &
 LICENSE PLATE - FORD & GENERAL PURPOSE**
 PKG: 15...75...150

1708



(OE 9437552)
**3/16" SPLIT RIVET - GM PRODUCTS
 DOOR LATCH ASSEMBLY**
 PKG: 25

1362

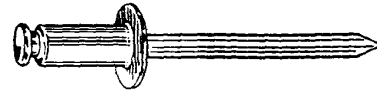

(OE 372820-S36)
**1/4" DIA. STEEL BUMPER RIVET
 YELLOW ZINC - FORD PRODUCTS**
 PKG: 25...125...250

1709



(OE 22579423, 22569178)
**3/16" SPLIT RIVET - GM PRODUCTS
 DOOR / WINDOW ASSEMBLY**
 PKG: 20

1672



(OE 388047-S102)
**1/4" DIA. DOOR HANDLE RIVET - PEEL TYPE
 ZINC & BLACK PHOSPHATE - FORD PRODUCTS**
 PKG: 25

1986

(OE N803138-S)
**3/16" SPLIT RIVET - ALUMINUM RIVET
 STEEL MANDREL**
 PKG: 20



SPECIAL APPLICATION RIVETS

1985



3.2mm (1/8") ALUMINUM RIVET - 5/16-3/8" GRIP
FORD & UNIVERSAL
PKG: 40...200...400

1934



(OE 90269-04051)
3.2mm (1/8") ALUMINUM RIVET **w/ PLASTIC SEAL**
3/64-1/8" GRIP - LEXUS & UNIVERSAL
PKG: 10...50...100

1911

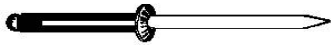

(OE N807620-S100)
4mm (5/32") SPLIT-TYPE RIVET - 3/64-1/4" GRIP
ALL ALUMINUM - BLACK - FORD & UNIVERSAL
PKG: 20...100...200

1909



(OE 90269-04053)
3.2mm (1/8") ALUMINUM RIVET **w/ PLASTIC SEAL**
3/64-3/16" GRIP - TOYOTA & UNIVERSAL
PKG: 10

1903



4.8mm SPLIT-TYPE RIVET - 3/64-11/32" GRIP
ALL ALUMINUM - BLACK - UNIVERSAL
PKG: 15



1669



(OE N805592-S100)
3/16" ALUMINUM RIVET - BLACK
FORD & GENERAL PURPOSE
PKG: 20...100...200

1913



(OE 90269-05054)
5mm (3/16") ALUMINUM RIVET **w/ PLASTIC SEAL**
1/8-5/16" GRIP - TOYOTA & UNIVERSAL
PKG: 10...50...100

1908



(OE N804851-S100)
1/4" ALUMINUM SPLIT-TYPE RIVET - BLACK
3/64-1/4" GRIP - FORD & UNIVERSAL
PKG: 10

1910



(OE 90269-06013)
6mm (1/4") ALUMINUM RIVET **w/ PLASTIC SEAL**
TOYOTA - LEXUS - UNIVERSAL
PKG: 10



PLASTIC RIVETS

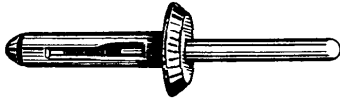

NYLON PLASTIC RIVETS - BLACK

BSF PART NO.	DIA.	PANEL RANGE	UNIT PKG.
-----------------	------	----------------	--------------

1380	5 mm	1/8-1/4"	25 - 125 - 250
1381	5 mm	1/4-3/8"	25 - 125 - 250
1382	6.3 mm	3/32-3/16"	25 - 125 - 250
1383	6.3 mm	5/32-3/8"	25 - 125 - 250

1710

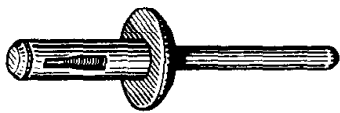

(OE 10109689)

**NYLON RIVET - 7mm HOLE
GM & UNIVERSAL**

PKG: 20

1891



(OE 20421672, 15955172)

**6.3mm NYLON RIVET - "SMALL FLANGE"
3/32"-3/16" GRIP RANGE**

PKG: 20...100...200

1892



(OE 20452072, N803862S)

**6.3mm NYLON RIVET - "SMALL FLANGE"
5/32"-3/8" GRIP RANGE**

PKG: 20...100...200

1932



(OE 51-71-7-002-953-2)

**5.6mm NYLON RIVET - BMW & UNIVERSAL
7/64"-3/16" GRIP RANGE**

















PKG: 20...100...200



"The Professionals' Choice"

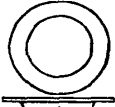

DOOR HINGE BUSHINGS

<p>1720</p>  <p>(OE 9721917) GM DOOR BUSHING (.344" I.D.) (.421" O.D.) (.296" OVERALL HEIGHT) PKG: 10</p>	<p>1726</p>  <p>(OE 9716926, 20345137) GM DOOR BUSHING (.341" I.D.) (.490" O.D.) (.358" OVERALL HEIGHT) PKG: 10</p>	<p>1725</p>  <p>(OE 9822198) GM DOOR BUSHING (.382" I.D.) (.504" O.D.) (.460" OVERALL HEIGHT) PKG: 10</p>	<p>1727</p>  <p>(OE 20429500) GM DOOR BUSHING (.344" I.D.) (.494" O.D.) (.360" OVERALL HEIGHT) PKG: 10</p>	<p>1723</p>  <p>(OE 12338074, 15691493) GM DOOR BUSHING (.344" I.D.) (.484" O.D.) (.359" OVERALL HEIGHT) PKG: 10</p>									
<p>1724</p>  <p>(OE 15562609) GM DOOR BUSHING (.391" I.D.) (.532" O.D.) (.359" OVERALL HEIGHT) PKG: 10</p>	<p>1956</p>  <p>(OE 15994486) GM DOOR BUSHING (.404" I.D.) (.492" O.D.) (.356" OVERALL HEIGHT) PKG: 10</p>			<p>1721</p>  <p>(OE D90Z-6522841A) (OE D20B-6522841AA) FORD DOOR BUSHING (.346" I.D.) (.477" O.D.) (.293" OVERALL HEIGHT) PKG: 10</p>									
<p>1722</p>  <p>(OE 4033711) CHRYSLER DOOR BUSHING (.269" I.D.) (.316" O.D.) (.356" OVERALL HEIGHT) PKG: 10</p>	<p>1754</p>  <p>(OE 4336115) CHRYSLER DOOR BUSHING (.252" I.D.) (.371" O.D.) (.391" OVERALL HEIGHT) PKG: 10</p>	<p>1753</p>  <p>(OE 2486468) CHRYSLER DOOR BUSHING (.346" I.D.) (.419" O.D.) (.444" OVERALL HEIGHT) PKG: 10</p>	<p>1957</p>  <p>JEEP BUSHING (.320" I.D.) (.408" O.D.) (.219" OVERALL HEIGHT) PKG: 10</p>										
<p>1759</p>  <p>(OE 80410-01G00) NISSAN DOOR BUSHING (8mm I.D.) (10mm O.D.) (10.5mm HEIGHT) PKG: 5</p>	<p style="text-align: center;">"E" CLIPS RETAINING RINGS</p>  <table style="width: 100%; border-collapse: collapse; margin-top: 10px;"> <thead> <tr> <th style="text-align: left; border-bottom: 1px solid black;">#</th> <th style="text-align: left; border-bottom: 1px solid black;">DIA.</th> <th style="text-align: left; border-bottom: 1px solid black;">QUAN</th> </tr> </thead> <tbody> <tr> <td>1959</td> <td>5/16"</td> <td>25</td> </tr> <tr> <td>1960</td> <td>3/8"</td> <td>25</td> </tr> </tbody> </table>	#	DIA.	QUAN	1959	5/16"	25	1960	3/8"	25	<p>1761</p>  <p>(OE 20052069) GM HINGE PIN CLIP (7.2mm I.D.) (10mm HEIGHT) PKG: 10</p>	<p>1762</p>  <p>(OE 4280729) CHRYSLER HINGE PIN CLIP (8.3mm I.D.) (9.85mm HEIGHT) PKG: 10</p>	<p>1763</p>  <p>(OE 15562610) GM HINGE PIN CLIP STAINLESS STEEL PKG: 20</p>
#	DIA.	QUAN											
1959	5/16"	25											
1960	3/8"	25											



DOOR HINGE PINS

1890



(OE 10102434)
GM TRUNK LID HINGE PIN
 11/32 x 2-21/32" LENGTH

PKG: 3 (BUSHING # 1720)

1963



GM DOOR HINGE PIN
 3/8 x 3" LENGTH

PKG: 2 (BUSHING # 1956)

1731



(OE 20043351)
GM DOOR HINGE PIN
 5/16 x 4" LENGTH

PKG: 3 (BUSHING # 1727)

1728



(OE 6500361)
CHRYSLER DOOR HINGE PIN
 1/4 x 2-5/32" LENGTH

PKG: 10

1730



(OE 6271989, 20046147)
GM DOOR HINGE PIN
 11/32 x 4-1/8" LENGTH

UNIT PKG. - 5 (BUSHING # 1720)

1729



(OE 6028993, 6032975)
CHRYSLER DOOR HINGE PIN
 1/4 x 2-5/8" LENGTH

PKG: 5 (BUSHING # 1722)

1733



(OE 12338015, 14066728)
GM DOOR HINGE PIN
 11/32 x 4-5/32" LENGTH

PKG: 3 (BUSHING # 1727)

1756



(OE 4280727, 5505125)
CHRYSLER DOOR HINGE PIN
 3/8 x 3-1/8" LENGTH

PKG: 2

1755



(OE 15653790)
GM DOOR HINGE PIN
 11/32 x 4-1/8" LENGTH

PKG: 2 (BUSHING # 1724)

1758

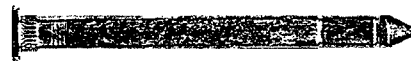

(OE E8UZ1522840)
FORD DOOR HINGE PIN
 11/32 x 3-1/2" LENGTH

PKG: 2 (BUSHING # 1721)

1732

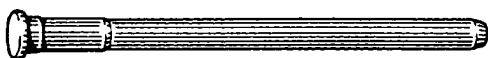

(OE 15591860, 15691595)
GM DOOR HINGE PIN
 11/32 x 5-1/4" LENGTH

PKG: 2 (BUSHING # 1723)

1760



(OE D9ZZ-6643030-AA)
FORD DOOR HINGE PIN
 11/32 x 3-3/8" LENGTH

PKG: 4 (BUSHING # 1721)



DOOR HINGE PINS

1964



FORD DOOR HINGE PIN
11/31 x 2-3/4" LENGTH

PKG: 2

1961



JEEP GRAND CHEROKEE HINGE PIN
1984 + UP

PKG: 4 (BUSHING # 1959)

1962

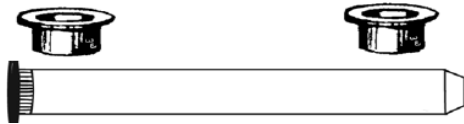

JEEP GRAND CHEROKEE KIT
(CONTAINS 2 PINS & 4 BUSHINGS)

PKG: 1

1757

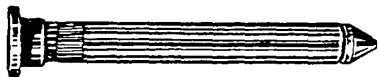

(OE 80406-V5002)
NISSAN DOOR HINGE PIN
8 x 72mm LENGTH

PKG: 2 (BUSHING # 1759)

1965

DOOR HINGE REPAIR KIT

GM C+K TRUCKS
1999 & UP

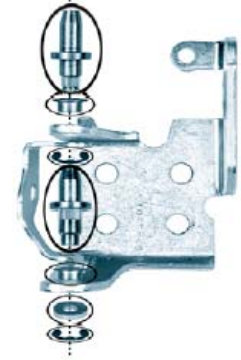

KIT CONTAINS 1 EACH LONG AND SHORT PINS, 2 BUSHINGS AND 2 E-CLIPS TO REPAIR ONE HINGE. (ACTUAL HINGE NOT INCLUDED)

PKG: 1 Set

1966

DOOR HINGE REPAIR KIT
DODGE RAM TRUCKS - 1994 & UP

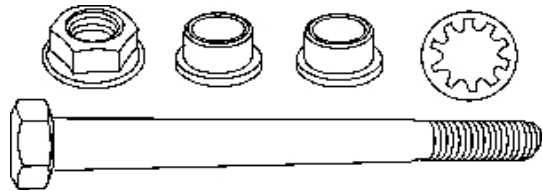

KIT CONTAINS 1 ZINC/YELLOW DICHROMATE GRADE "8" BOLT, 2 SELF LUBRICATING BRASS ALLOY BUSHINGS, 1 ZINC PLATED SPIN LOCK NUT AND 1 INTERNAL LOCK WASHER.

PKG: 1 Set

1958



GM DOOR ROLLER PIN ASSEMBLY
GM CK LIGHT DUTY TRUCK

PKG: 1



NYLON WIRE STRAPS & ROUTING CLIPS



NYLON CABLE TIES

BSF PART NO.	LENGTH	COLOR	UNIT PKG.
1373	7.5"	BLACK	50
1769	11"	BLACK	25



WIRE LOOM ROUTING CLIPS

BSF PART NO.	SIZE	UNIT PKG.
1665	.413 I.D.	25
1374	1/2" I.D.	20
1375	3/4" I.D.	15



(OE 90672-SA0-0030)

CABLE STRAP - 7 mm HOLE HONDA / MAZDA

BSF PART NO.	LENGTH	UNIT PKG.
1713	5.5" (140mm)	20
1931	8" (200mm)	15

2005

WIRE LOOM ROUTING CLIP 1/4" INSIDE DIAMETER

PKG: 10



2006

WIRE LOOM ROUTING CLIP 10mm INSIDE DIAMETER

PKG: 10

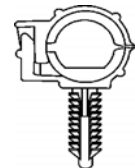

1376



UNIVERSAL WIRING STRAP - 2-3/4" LONG

PKG: 50

2007

CONVOLUTED WIRING HARNESS CLIP - GM & UNIV 1/2" DIA. - 1/4" HOLE

PKG: 10



1377



UNIVERSAL WIRING STRAP - 4" LONG

PKG: 50

2008

WIRE LOOM ROUTING CLIP 19mm INSIDE DIAMETER

PKG: 10



2003

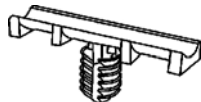

WIRE HARNESS CLIP 1/4" HOLE - GM & UNIVERSAL

PKG: 25

2004

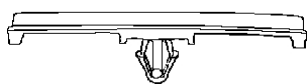

WIRE HARNESS CLIP 1/4" HOLE - GM & UNIVERSAL

PKG: 10

2002

(OE 25512081, 386132-S, 386132)

WIRE LOOM ROUTING CLIP 1/4" DIA. - 1/4" HOLE - GM, FORD, CHRYSLER

PKG: 25



SOLDERLESS TERMINALS - VINYL INSULATED



RING TONGUES

PART #	COLOR	RANGE	STUD SIZE	PKG.
1400.....	RED.....	22-18.....	8-10.....	50
1401.....	BLUE.....	16-14.....	8-10.....	50
1402.....	BLUE.....	16-14.....	12-1/4".....	25
1403.....	BLUE.....	16-14.....	5/16-3/8".....	25
1404.....	YELLOW.....	12-10.....	8-10.....	25
1405.....	YELLOW.....	12-10.....	12-1/4".....	25
1406.....	YELLOW.....	12-10.....	5/16-3/8".....	25



BUTT CONNECTORS

PART #	COLOR	RANGE	PKG.
1414.....	RED.....	22-18.....	50
1415.....	RED.....	22-18.....	200
1416.....	BLUE.....	16-14.....	50
1417.....	BLUE.....	16-14.....	200
1418.....	YELLOW.....	12-10.....	25
1419.....	YELLOW.....	12-10.....	100



SPADE TONGUES

PART #	COLOR	RANGE	STUD SIZE	PKG.
1407.....	RED.....	22-18.....	8-10.....	50
1408.....	BLUE.....	16-14.....	8-10.....	50
1409.....	YELLOW.....	12-10.....	8-10.....	25

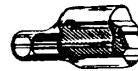

FULLY INSULATED QUICK DISCONNECTS 16-14 WIRE SIZE - BLUE

MALE

1420

PKG: 25

FEMALE

1421

PKG: 25

1422



FULLY INSULATED T-TAP

16-14 WIRE SIZE - BLUE

(USE WITH BSF #1420)

PKG: 20



FEMALE QUICK - DISCONNECTS

PART #	COLOR	RANGE	PKG.
1410.....	BLUE.....	16-14.....	50
1411.....	YELLOW.....	12-10.....	50



FULLY INSULATED SNAP PLUGS

16-14 WIRE SIZE - BLUE

MALE

1423

PKG: 50

FEMALE

1424

PKG: 25



MALE QUICK - DISCONNECTS

PART #	COLOR	RANGE	PKG.
1412.....	BLUE.....	16-14.....	50
1413.....	YELLOW.....	12-10.....	50



QUICK ELECTRICAL CONNECTORS

14-16-18 GAUGE WIRE - BLUE

1425 - PKG. - 25

1426 - PKG. - 100



HEAT SHRINK - CRIMP & SEAL - TERMINALS



RING TONGUES

PART #	COLOR	RANGE	STUD SIZE	PKG.
2041	RED	22-18	#6	10 / 50
2042	RED	22-18	#10	10 / 50
2043	BLUE	16-14	#8	10 / 50
2044	BLUE	16-14	#10	10 / 50
2045	BLUE	16-14	1/4"	10 / 50
2046	BLUE	16-14	3/8"	10 / 50
2047	YELLOW	12-10	#8	10 / 50
2048	YELLOW	12-10	#10	10 / 50
2049	YELLOW	12-10	1/4"	10 / 50
2050	YELLOW	12-10	3/8"	10 / 50



SPADE TONGUES

PART #	COLOR	RANGE	STUD SIZE	PKG.
2051	RED	22-18	8-10	10 / 50
2052	BLUE	16-14	8-10	10 / 50
2053	YELLOW	12-10	8-10	10 / 50



HEAT SHRINK TUBING BLACK * SINGLE WALL * 2:1

PART #	COLOR	SIZE	PKG.
2072	BLACK	1/8"	20
2073	BLACK	3/16"	20
2074	BLACK	1/4"	20



MALE QUICK - DISCONNECTS

PART #	COLOR	RANGE	PKG.
2054	RED	22-18	10 / 50
2055	BLUE	16-14	10 / 50
2056	YELLOW	12-10	10 / 50



FEMALE QUICK - DISCONNECTS

PART #	COLOR	RANGE	PKG.
2057	RED	22-18	10 / 50
2058	BLUE	16-14	10 / 50
2059	YELLOW	12-10	10 / 50



BUTT CONNECTORS

PART #	COLOR	RANGE	PKG.
2060	RED	22-18	10 / 50
2061	BLUE	16-14	10 / 50
2062	YELLOW	12-10	10 / 50



... The Professionals' Choice



FUSES / AUTOMOTIVE LIGHTING



ATO/ATC FUSES

BSF PART NO.	SIZE	COLOR	PKG.
ATO-3.....	3 AMP.....	VIOLET.....	5 - 20
ATO-5.....	5 AMP.....	TAN.....	5 - 20
ATO-7.5.....	7.5 AMP.....	BROWN.....	5 - 20
ATO-10.....	10 AMP.....	RED.....	5 - 20
ATO-15.....	15 AMP.....	BLUE.....	5 - 20
ATO-20.....	20 AMP.....	YELLOW.....	5 - 20
ATO-25.....	25 AMP.....	WHITE.....	5 - 20
ATO-30.....	30 AMP.....	GREEN.....	5 - 20



ATM MINI-FUSES

BSF PART NO.	SIZE	COLOR	PKG.
ATM-2.....	2 AMP.....	GRAY.....	5 - 20
ATM-3.....	3 AMP.....	PURPLE.....	5 - 20
ATM-4.....	4 AMP.....	PINK.....	5 - 20
ATM-5.....	5 AMP.....	TAN.....	5 - 20
ATM-7.5.....	7.5 AMP.....	BROWN.....	5 - 20
ATM-10.....	10 AMP.....	RED.....	5 - 20
ATM-15.....	15 AMP.....	BLUE.....	5 - 20
ATM-20.....	20 AMP.....	YELLOW.....	5 - 20
ATM-25.....	25 AMP.....	WHITE.....	5 - 20
ATM-30.....	30 AMP.....	GREEN.....	5 - 20

HEADLIGHT BULBS















D2R XENON-HID	D2S XENON-HID	2004 FORD HALOGEN	9003 (H4)	9004	9005 - High	9006 - Low
9007	9008 (H13) High-Low Beam		H7	H8 (12v-35w)	H9 (12v-65w)	H11 (12v-55w)

SPECIAL HALOGEN LAMPS - FOG / AUX

H1	H3		H10 (9145) (12v-45w)	880	881	884/885
886	889	890	891	893		





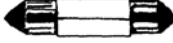
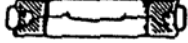



MINIATURE AUTOMOTIVE BULBS

 74	 24 24NA	 194 194NA	 57 67	 1815 1816	 1893	 906 906NA	 912	
 916 916NA	 921 922	 1156 1156NA	 1295 1295NA	 1157 1157NA	 2057 2057NA	 2357 2357NA	 211-2 212-2	 561





WEDGE - TYPE BULBS

	3057 3057NA 3156 3156NA 3157	3157NA 3457 3457NA 3757AK 4114K	4157LL 4157NALL 5702AK
--	--	---	------------------------------

JAPANESE BULBS

 * Krypton * 3652	 3175	 * Krypton * * Nickel - Base * 3496	 * Krypton * * Nickel - Base * 3497	 7440 7440NA	 7443 7443NA
--	---	---	---	---	---

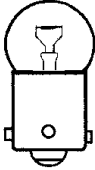
EUROPEAN BULBS

2721 (Repl 12516) (Repl 17037) <hr/>					
2825 (Repl 12961) (Repl 17177)	3175 (12100, 17315) 3423 (12844, 11005)	3021 (12818, 11006) 3022 (12094, 13050) 6411 (12866, 17314)	* Nickel - Base * 5007 (12821, 17171) 5008 (12814, 17311)	* Nickel - Base * 7506 (12498, 17635) 7507(A) (12496, 17638A)	* Nickel - Base * 7225 (12594, 17881) 7528 (12499, 17916)



DRILL BITS



HIGH - SPEED "STUBBY" DRILL BITS

* TOP QUALITY - U.S. MADE - 135° SPLIT POINT *

BSF PART NO.	SIZE	TYPE	PKG.
DB-18.....	1/8".....	SINGLE END.....	12
DB-18X.....	1/8".....	DOUBLE END.....	12
DB-36X.....	3/16".....	DOUBLE END.....	3
DB-14X.....	1/4".....	DOUBLE END.....	3

ULTRA - STEP DRILLS

* MADE IN USA - TOP QUALITY *



BSF PART NO.	SIZE	PKG.
S-130.....	1/8 to 1/2".....	1



S-140.....	3/16 to 1/2".....	1
------------	-------------------	---



S-150.....	3/16 to 7/8".....	1
------------	-------------------	---



S-160.....	1/4 to 3/4".....	1
------------	------------------	---

SPOT WELD BITS



HIGH - SPEED SPOT WELD DRILLS

* COBALT STEEL * TITANIUM COATED * MADE IN USA *

SIZE	PART NO.	PKG.	SIZE	PART NO.	PKG.
8 mm.....	CD-8.....	1	10 mm.....	CD-10.....	1
8 mm.....	CD-8B.....	3	10 mm.....	CD-10B.....	3



* FLAT EDGE BASE *
* COBALT STEEL - TITANIUM COATED *

SIZE	PART NO.	PKG.	SIZE	PART NO.	PKG.
8 x 45mm..	CF-8.....	1	8 x 37mm..	CS-8.....	1
8 x 45mm..	CF-8B.....	3	8 x 37mm..	CS-8B.....	3



BITS FOR BORON STEEL

* CARBIDE STEEL * TITANIUM COATED *

SIZE	PART NO.	PKG.
8 mm.....	CZ-8.....	1
8 mm.....	CZ-8B.....	3



BITS FOR BORON STEEL

* FLAT EDGE BASE *
* CARBIDE STEEL * TITANIUM COATED *

SIZE	PART NO.	PKG.
8 x 45mm..	CY-8.....	1
8 x 45mm..	CY-8B.....	3



MISCELLANEOUS SUPPLIES

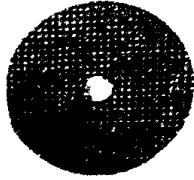

HIGH SPEED CUT-OFF WHEELS

* MADE IN U.S.A *

BSF

PART NO.	SIZE	PKG
3003.....	3" x 1/16".....	5
3004.....	3" x 1/16".....	25
3005.....	3" x 3/16".....(THICK).....	2

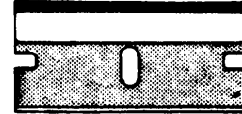

SINGLE EDGE INDUSTRIAL RAZOR BLADES

3006 - PKG: 100



2" x 3" RUBBER SQUEEGEES

BSF

PART NO.	COLOR	PKG
3000.....	RED.....	6

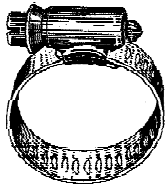

HOSE CLAMPS HEX SLOTTED SCREW WORM GEAR TYPE

BSF

PART NO.	CLAMP RANGE MIN - MAX	PKG
HC-M4 <i>MINI</i>	1/4 - 5/8".....	10
HC-M6 <i>MINI</i>	1/2 - 7/8".....	10
HC-10.....	1/2 - 1-1/8".....	10
HC-12.....	1/2 - 1-1/4".....	10
HC-16.....	3/4 - 1-1/2".....	10
HC-20.....	3/4 - 1-3/4".....	10
HC-24.....	1 - 2".....	10
HC-28.....	1-5/16 - 2-1/4".....	10
HC-32.....	1-9/16 - 2-1/2".....	10
HC-36.....	7/8 - 2-3/4".....	10

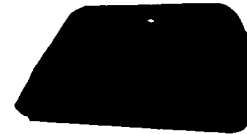

3" x 4" YELLOW SPREADERS

BSF

PART NO.	COLOR	PKG
3002.....	YELLOW.....	6





DRAWERS, RACKS & BINS

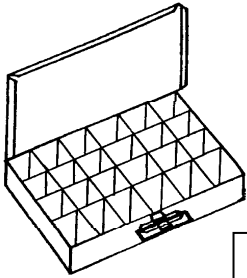

LARGE DRAWERS

AVAILABLE SIZES

C-15 C-24
C-20 C-32

18" WIDE x 12" DEEP x 3" HIGH

OUR "TOP QUALITY" LARGE STEEL DRAWER ARE MADE FROM HIGHLY DURABLE COLD-ROLLED STEEL AND INCLUDE HIGH-IMPACT PLASTIC INSERTS.

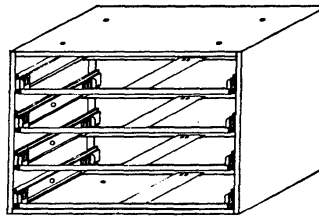

LARGE RACK

PART

C - 4R

20" WIDE x 15-3/4" DEEP x 14-1/2" HIGH

EACH LARGE RACK IS DESIGNED TO HOLD 4 OF OUR LARGE DRAWERS.

(DRAWERS ARE NOT INCLUDED AND MUST BE ORDERED SEPERATELY.)

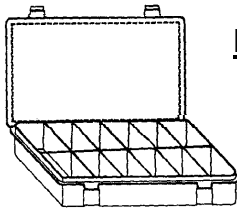

LARGE PLASTIC BINS

13" WIDE x 9" DEEP x 2-5/16" HIGH

AVAILABLE BINS

LP - 6 LP - 18
LP - 12 LP - 24
LP - 16 -----

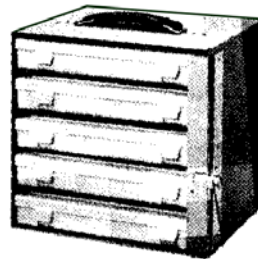

RACK FOR LARGE PLASTIC BINS

PART

LP - 1

OUR HIGH QUALITY "LARGE" STEEL RACKS WILL HOLD UP TO 5 LARGE PLASTIC BINS.

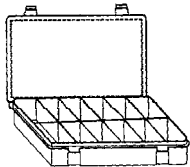

SMALL PLASTIC BINS

11" WIDE x 6-3/4" DEEP x 1-3/4" HIGH

AVAILABLE BINS

SP - 6
SP - 12
SP - 18

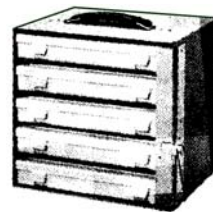

RACK FOR SMALL PLASTIC BINS

PART

SP - 1

OUR HIGH QUALITY "SMALL" STEEL RACKS WILL HOLD UP TO 5 SMALL PLASTIC BINS.



36 COMPARTMENT STORAGE BIN

PART

B - 36

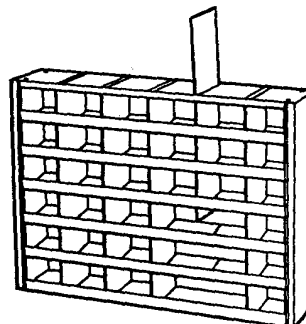

THIS MULTI-PURPOSE BIN FEATURES REMOVABLE VERTICAL DIVIDERS AND CAN BE WALL MOUNTED.

23-3/4" WIDE x 4-3/4" DEEP x 12-1/4" HIGH

